



Solenoid valve 2/2 way N.C. Combined operation

21IH3K1V150
÷
21IH8K1V400

PRESENTATION:

Combined operation S.V. for interception of fluids compatible with the construction materials.
Minimum operational pressure is not required.
The materials used and the tests carried out ensure maximum reliability and duration.

USE: Automation - Heating - Chemistry

PIPES: G 3/8 - G 1 1/2

COILS:

8W - Ø 13	
BDA - BDS - BSA	155°C (class F)
BDF - BDV	180°C (class H)
12W - Ø 13	
UDA	155°C (class F)
14W - Ø 13	
GDA - GDS	155°C (class F)
GDH - GDV	180°C (class H)

MOULDING AND BOBBIN ARE MADE BY 100% VIRGIN MATERIAL.

Max. allowable pressure (PS)	16 bar
Ambient temperature:	
with coils class F	- 10°C + 60°C
with coils class H	- 10°C + 80°C



Gaskets	Temperature		Medium
	- 10°C	+140°C	
V=FKM (fluoroelastomer)	- 10°C	+140°C	Mineral oils (2°E), gasoline gas oil
B=NBR (nitrile rubber)	- 10°C	+ 90°C	Air, inert gas, water

Per tenute diverse dal FKM sostituire la lettera "V" con le lettere corrispondenti alle altre tenute. Es. 21IH3K1**B**150.

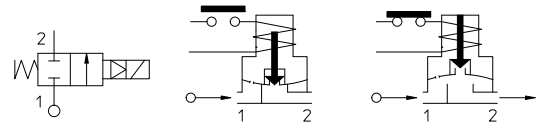

Pipe ISO 228/1	Code	Max viscosity		Ø mm	Kv l/mn	Power (watt)	Pressure		
		cSt	°E				min bar	M.O.P.D. AC bar DC bar	
G 3/8	21IH3K1V150	12	~ 2	15	40	8	0	14	6
						12		-	14
G 1/2	21IH4K1V160	12	~ 2	16	50	8	0	14	6
						12		-	14
G 3/4	21IH5K1V200	12	~ 2	20	60	8	0	14	6
						12		-	14
G 1	21IH6K1V250	12	~ 2	25	140	8	0	14	3
						12		-	8
G 1 1/4	21IH7K1V350	12	~ 2	35	300	14	0	14	-
								12	-
G 1 1/2	21IH8K1V400	12	~ 2	40	340	14	0	14	-



CE Approval

(Pressure Equipment Directive 97/23/CE)
for S.V. 21IH7÷21IH8

The "ODE" reserves the right to carry out technical and aesthetic modifications without prior notification.

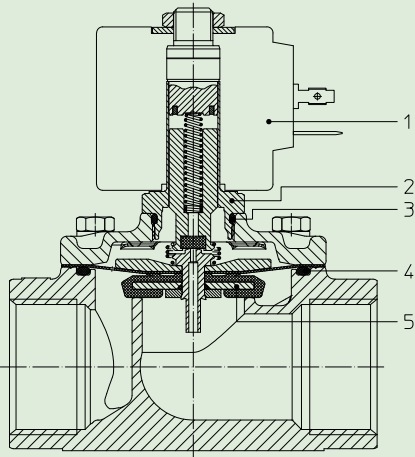
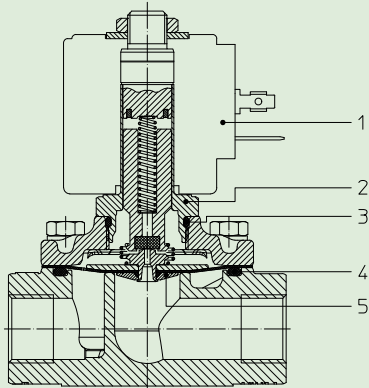

MATERIALS:

- Body** Stainless steel AISI 316
- Armature tube** Stainless steel AISI 316
- Fixed core** Stainless steel AISI series 400
- Plunger** Stainless steel AISI series 400
- Phase displacement ring** Gold plated copper
- Spring** Stainless steel AISI series 300
- Seal** Standard: V=FKM
On request: B=NBR
- Orifice** Stainless steel AISI 316

- On request:**
- Connector** Pg 9 o Pg 11
- Connector conformity** ISO 4400

FEATURES:

- Electrical conformity** IEC 335
- Protection degree** IP 65 EN 60529 (DIN 40050)
with coil fitted by connector.

SPARE PARTS:

- 1. Coil:** G 3/4 Code R452899/V
See coils list G 1 Code R452846/V
- 2. Complete plunger:** G 1 1/4÷ G 1 1/2 Code R452904/V
Code R450811
- 3. Gasket O-Ring:** Code R990000/V
- 4. Gasket O-Ring:** G 3/8÷G1/2 Code R990105/V
G 3/4 Code R992103/V
G 1 Code R992109/V
G 1 1/4 ÷ G 1 1/2 Code R992101/V
- 5. Complete diaphragm with plunger:** G 3/8÷G1/2 Code R452894/V

MAINTENANCE KIT:

- G 3/8 ÷ G 1/2
- KTGIH3K1V15=4+5
- G 3/4
- KTGIH5K1V20=4+5
- G1
- KTGIH6K1V25=4+5
- G 1 1/4 ÷ G 1 1/2
- KTGIH7K1V35=4+5

DIMENSIONS:

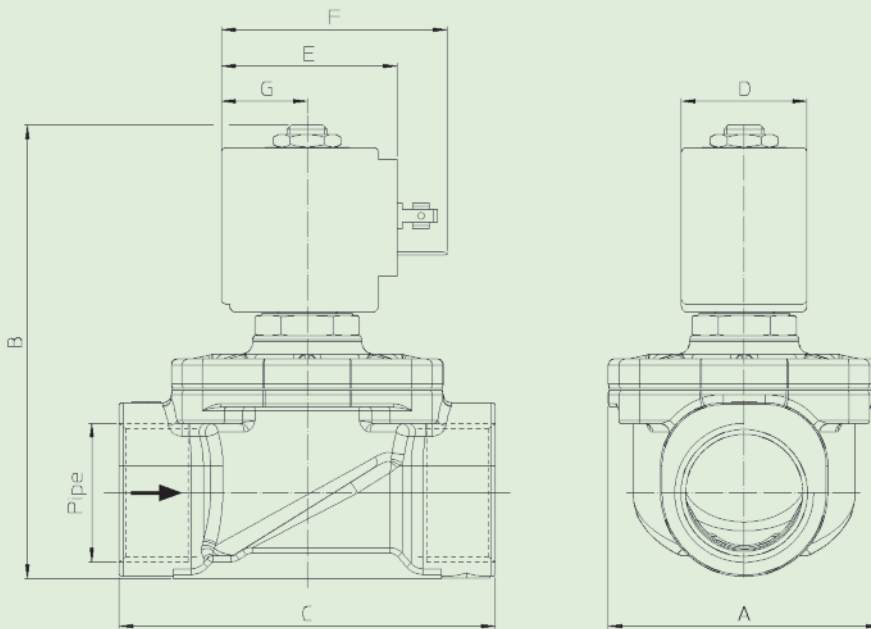

Type	Pipe ISO 228/1	A mm	B mm	C mm
21IH3K1V150	G 3/8	52	92	68
21IH4K1V160	G 1/2			
21IH5K1V200	G 3/4	58	100	75
21IH6K1V250	G 1	65	109	90
21IH7K1V350	G 1 1/4	94	126	128
21IH8K1V400	G 1 1/2			

COIL TYPE	POWER ABSORPTION			DIMENSIONS			
	W ==	Hold VA ~	Inrush VA ~	D mm	E mm	F mm	G mm
B	8	14,5	25	30	42	54	20,5
U	12	23	35	36	48	60	23,5
G	14	27	43	52	55	67	25